

BARRIER TYPE

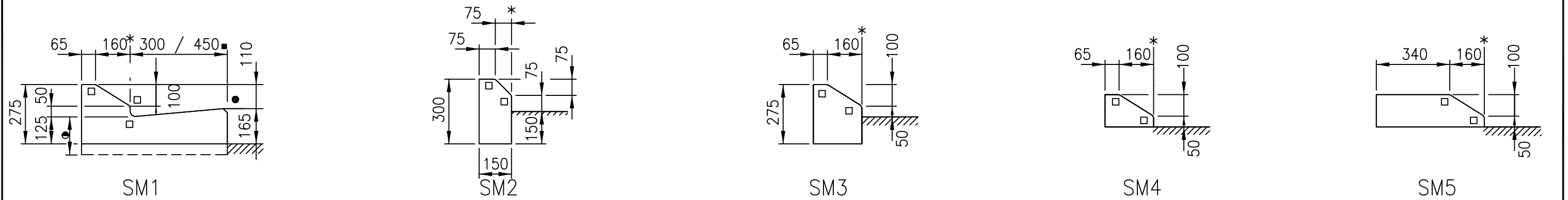

SEMI - MOUNTABLE TYPE

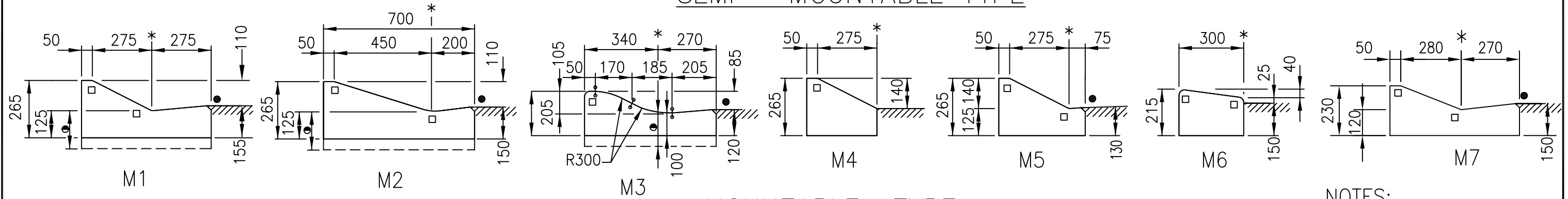

MOUNTABLE TYPE

NOTES:

1. All materials and construction shall comply with AS 2876 except for dimensions on this drawing.
2. All concrete N25 min (refer project documentation) in accordance with AS1379 and AS 3600.
3. Reinforcing steel to AS 4671.
4. All dimensions in millimetres.

LEGEND

- * Nominal kerb line for setting out.
- Channel, invert width - refer project dwgs.
- 20 Arris.
- R20 Radius.
- 175 where specified for commercial and industrial applications, refer project dwgs.

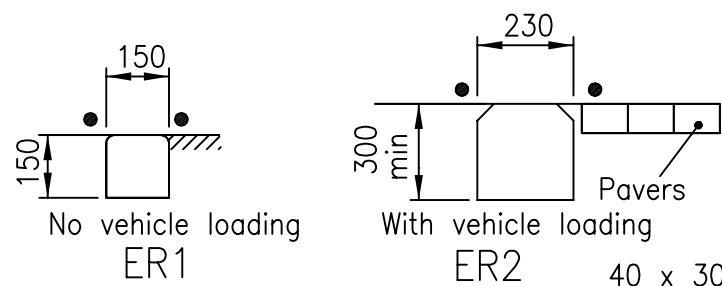

40 x 300 Stripdrain where specified, discharge to table drain/side drain via 'Nylex' end outlet fitting

EDGE RESTRAINT

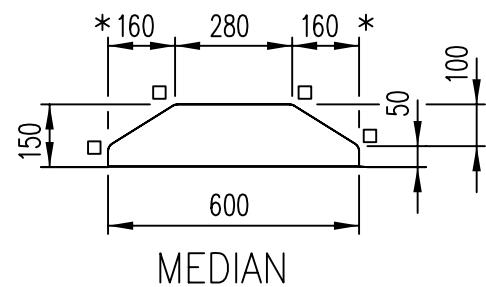

MEDIAN

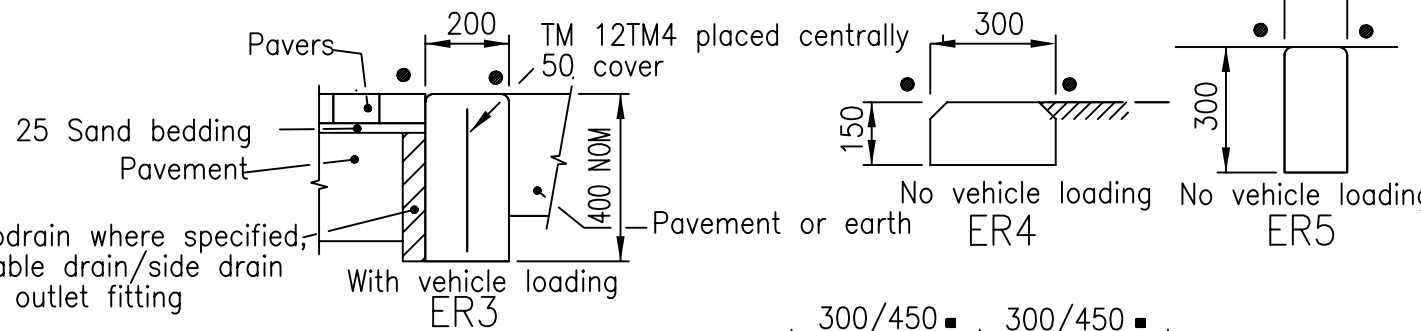

INVERT

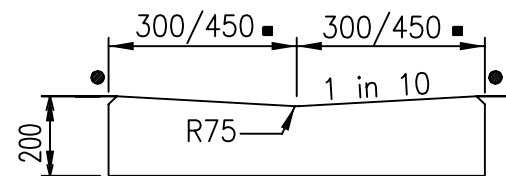

These drawings have been developed in consultation between the participating councils. BEFORE USE, the user shall confirm that the drawing has been adopted by the appropriate council

A	3/08	ORIGINAL ISSUE
Rv.	DATE	REVISIONS

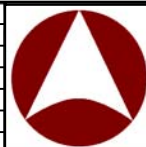

INSTITUTE OF PUBLIC WORKS ENGINEERING AUSTRALIA
QUEENSLAND DIVISION INC.
STANDARD DRAWINGS

KERB AND CHANNEL
PROFILES AND DIMENSIONS
INCLUDING EDGE RESTRAINTS, MEDIAN & INVERT

SEQ R-080

A/Rv.